

ELITE ELEVATOR



Contact Name: _____

Job Name: _____

Email Address: _____

Location: _____

NOTES

BASE PACKAGE

Includes 2 landings, 1 opening, cab model 3636 or 3648, winding drum drivetrain, 8lb. guide rails, travel cable, PLC controller and optical landing system, terminal and final limits, 2 recessed LED automatic cab lights, stainless steel fixtures with blue LED buttons, phone, standard flat wall cab finish, 1 door lock per level.

HOISTWAY

Hoistway Size

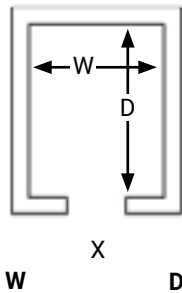

Rail Location

LEFT

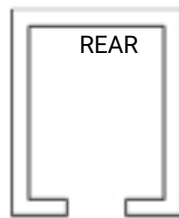

RIGHT

Landings

2	5
3	6
4	7

Hoistway Construction

- Wood
- Concrete

Note: Refer to Master Cab Configuration file for recommended standard hoistway sizes.

CAB

Cab Model

- 3636
- 3648
- 3660
- 4254
- 4836

Cab Configuration

- Front Opening
- Pass Through
- 90 degree opening

Cab Height

- 6' 8"
- 7' 0"
- 8' 0"

CAB FINISHES

Standard Flat Laminate



- Finish
- White
 - Beige
 - Black
 - Other

Flat Wood Veneer



- Unfinished
- Maple
 - Oak
 - Cherry
 - Mahogany

Traditional

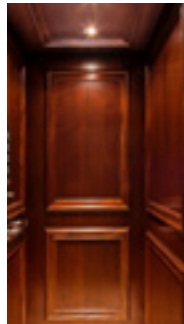

- Unfinished
- Maple
 - Oak
 - Cherry
 - Mahogany

Shaker Style

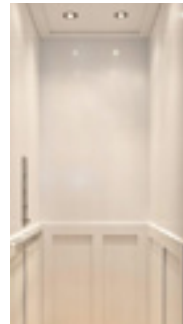

- Finish
- White
 - Unfinished
 - Maple

Lights



2 LED



4 LED











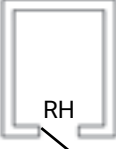
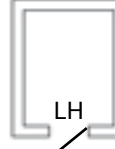
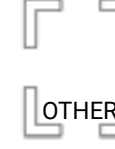
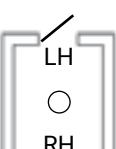
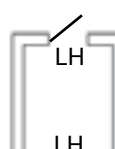
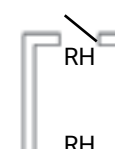

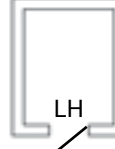
Fixture Finish

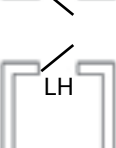
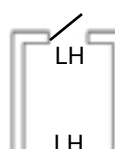
- #4 Brushed Stainless
- Bronze
- Copper Vein

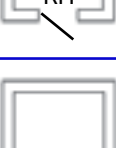
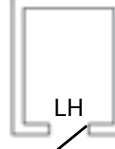
Fixture Shape

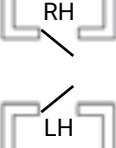
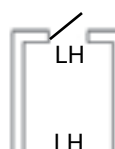
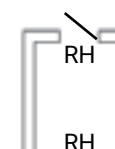
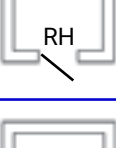
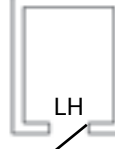
- Traditional
- Oval

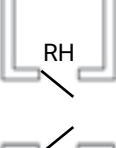
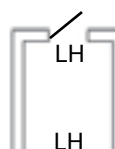
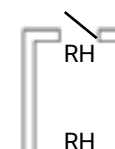
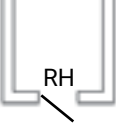
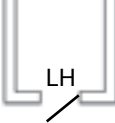
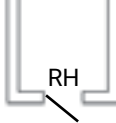
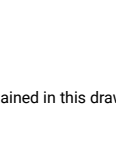
Select hoistway door configuration for each floor level.

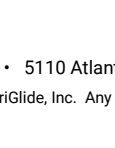
DOOR SWING	LEVEL 4			
				
				
				
				
				
	LEVEL 3			
				
				
				
LEVEL 2				
LEVEL 1				

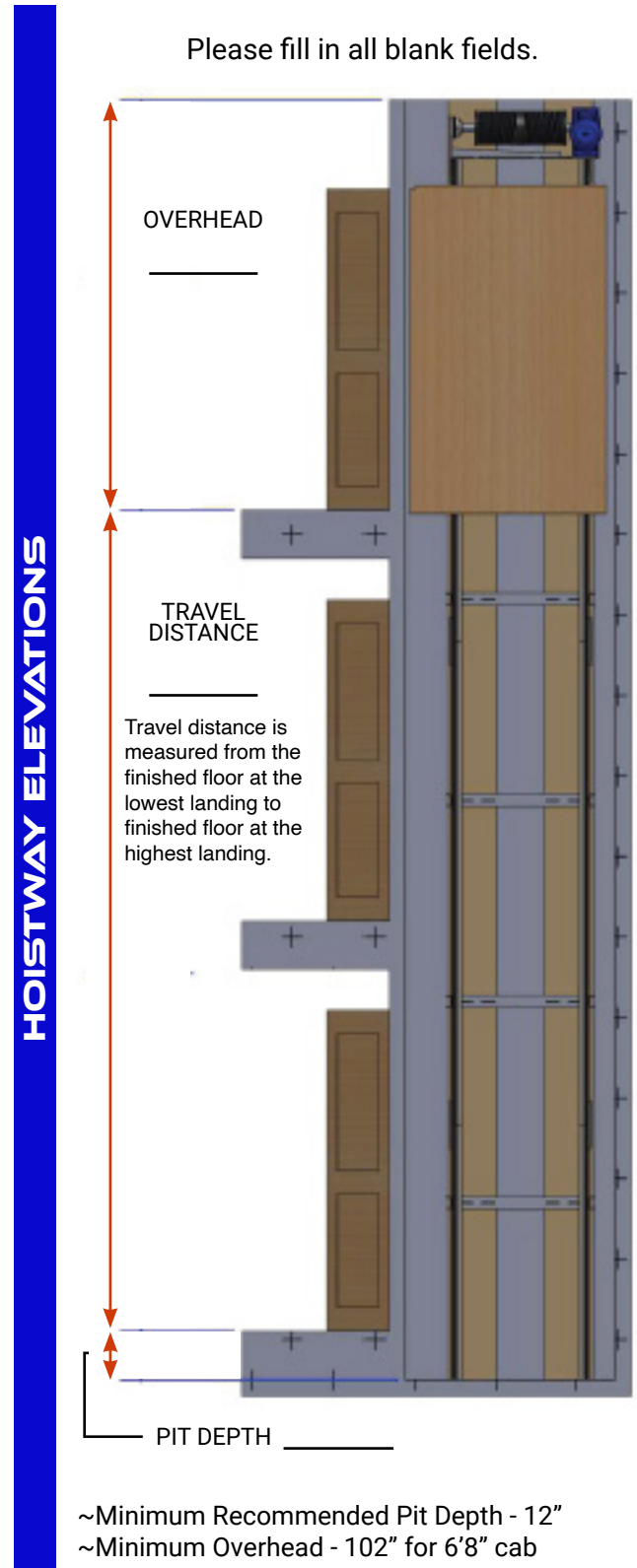

ELITE ELEVATOR



STANDARD FEATURES

- » PLC Based Controller, ETL Listed
- » Terminal and Final Limits
- » Optical Landing System
- » 2nd Level Homing
- » Blue LED Call Buttons
- » Automatic Cab Lights
- » Travel Cable
- » Cartop Box
- » Phone
- » 2 Drawing Revisions

MACHINE ROOM

Controller/Machine Room Location:

- Adjacent
- Remote _____ feet
- Standard Travel Cable (hoistway length + 20ft)
- Extra Travel Cable
- Controller for Stops 5-7

GATES

Standard Vinyl

- White
- Tan
- Gray

Wood Grain Vinyl

- Maple
- Natural Oak
- Dark Oak

Natural Wood Veneer

- Maple
- Oak
- Mahogany
- Cherry

Acrylic

- Clear

OPTIONS

- Battery Lowering w/ e-light
- Additional Door Locks QTY _____
- Automatic Gate Operator QTY _____
- Security Keypad
- Float Switch
- Door Baffles QTY _____
- Custom Platform Size
- Excess Travel Distance _____
- Round Handrail
- Additional Drawing Revisions QTY _____
- Wiring Kit

DRIVE

- Winding Drum - 950 lb. capacity
- Roped Hydraulic

OPTIONAL DOOR JAMBS

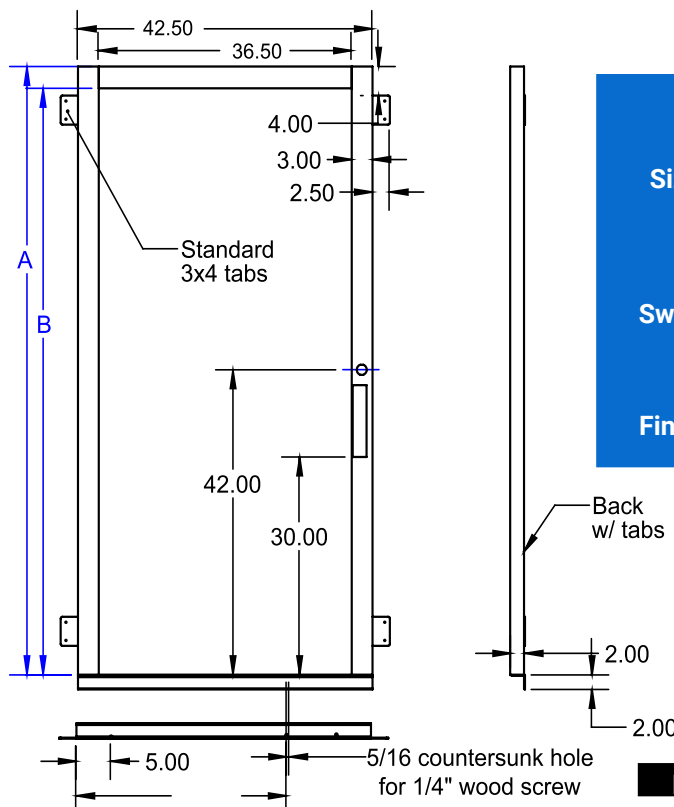

	Quantity
Size	80" _____
	84" _____
	96" _____
Swing	Right _____
	Left _____
Finish	White _____
	Beige _____



36" wide door panel provided by others. Integrated self closing hinge and honeywell realign door lock with LED call button. Strike plate kit included with frame.

Door Size	r/o Frame Size	A	B
36x80	44 x 84.5	83.75	80.75
36x84	44 x 88.5	87.75	84.75
36x96	44 x 100.5	99.75	96.75